

2

1

### Tee Reducing PVC Cat 19 50mm X 40mm

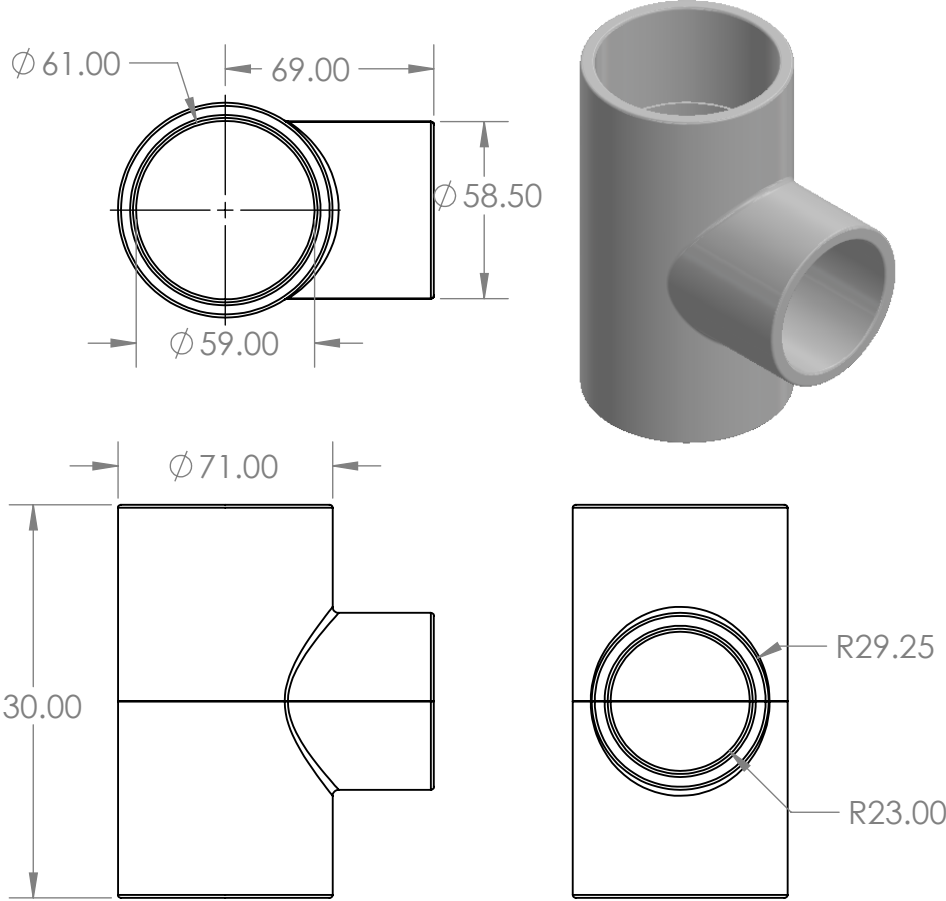

#### Description

Pressure fittings are used for a large variety of high-pressure water applications. Including irrigation and water reticulation. Aztec PVC Pressure fittings comply with AS/NZS 1477.

- Comply with AS/NZS 1477
- WaterMark certified
- Comply with AS/NZS 4020 for drinking water application
- BEP - PVC certified
- Pressure ratings: PN18 ( $\leq$  DN50), PN15 ( $>$  DN50)
- Joint types: Solvent Cement Joint (SCJ) or Threaded (BSP)
- Size range: DN15 - DN150
- Working temperature: 0°C - 50°C
- Colour: White

B

B

A

A



**PROPRIETARY AND CONFIDENTIAL**

THE INFORMATION CONTAINED IN THIS DRAWING IS THE SOLE PROPERTY OF AZTEC AUSTRALASIA. ANY REPRODUCTION IN PART OR AS A WHOLE WITHOUT THE WRITTEN PERMISSION OF AZTEC AUSTRALASIA IS PROHIBITED.

		UNLESS OTHERWISE SPECIFIED:		NAME	DATE
		DIMENSIONS ARE IN INCHES	DRAWN		
		TOLERANCES:	CHECKED		
		FRACTIONAL $\pm$	ENG APPR.		
		ANGULAR: MACH $\pm$ BEND $\pm$	MFG APPR.		
		TWO PLACE DECIMAL $\pm$	Q.A.		
		THREE PLACE DECIMAL $\pm$	COMMENTS:		
		INTERPRET GEOMETRIC TOLERANCING PER:			
		MATERIAL			
		FINISH			
NEXT ASSY	USED ON				
APPLICATION		DO NOT SCALE DRAWING			

TITLE:		
SIZE	DWG. NO.	REV
<b>A</b>	<b>PF195040</b>	
SCALE: 1:2	WEIGHT:	SHEET 1 OF 1

2

1