

Elbow FI Cat 15 PVC Pressure 20mm x 1/2" x 90°

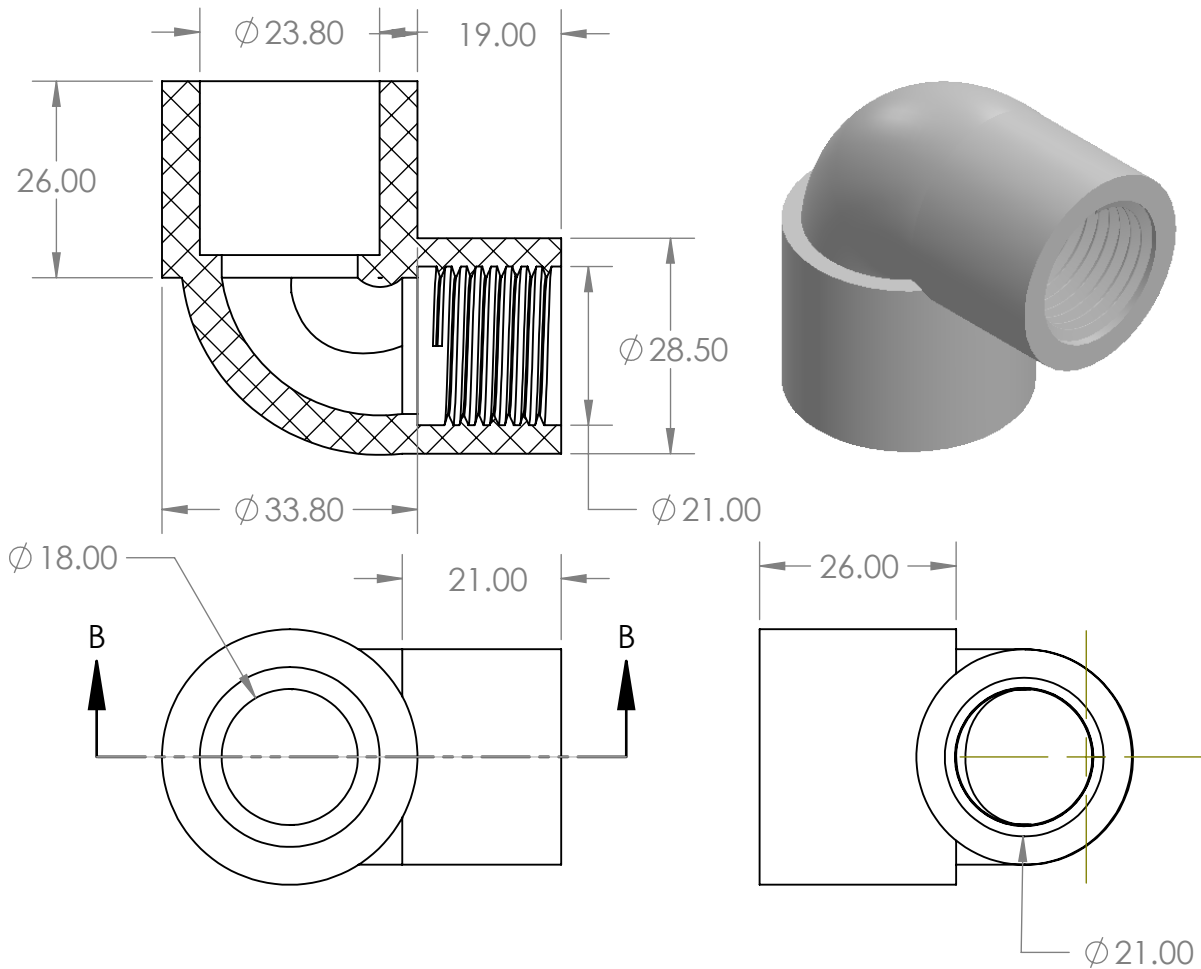

Description

Pressure fittings are used for a large variety of high-pressure water applications. Including irrigation and water reticulation. Aztec PVC Pressure fittings comply with AS/NZS 1477.

- Comply with AS/NZS 1477
- WaterMark certified
- Comply with AS/NZS 4020 for drinking water application
- BEP - PVC certified
- Pressure ratings: PN18 (\leq DN50), PN15 ($>$ DN50)
- Joint types: Solvent Cement Joint (SCJ) or Threaded (BSP)
- Size range: DN15 - DN150
- Working temperature: 0°C - 50°C
- Colour: White

B

B

A

A



PROPRIETARY AND CONFIDENTIAL

THE INFORMATION CONTAINED IN THIS DRAWING IS THE SOLE PROPERTY OF AZTEC AUSTRALASIA. ANY REPRODUCTION IN PART OR AS A WHOLE WITHOUT THE WRITTEN PERMISSION OF AZTEC AUSTRALASIA IS PROHIBITED.

		UNLESS OTHERWISE SPECIFIED:		NAME	DATE
		DIMENSIONS ARE IN INCHES	DRAWN		
		TOLERANCES:	CHECKED		
		FRACTIONAL \pm	ENG APPR.		
		ANGULAR: MACH \pm BEND \pm	MFG APPR.		
		TWO PLACE DECIMAL \pm	Q.A.		
		THREE PLACE DECIMAL \pm	COMMENTS:		
		INTERPRET GEOMETRIC TOLERANCING PER:			
		MATERIAL			
		FINISH			
NEXT ASSY	USED ON				
APPLICATION		DO NOT SCALE DRAWING			

TITLE:		
SIZE	DWG. NO.	REV
A	PF152015	
SCALE: 1:1	WEIGHT:	SHEET 1 OF 1