

2

1

Saddle Galvanised Pipe 25mm

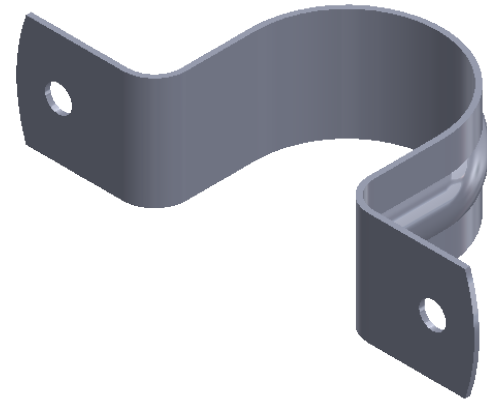
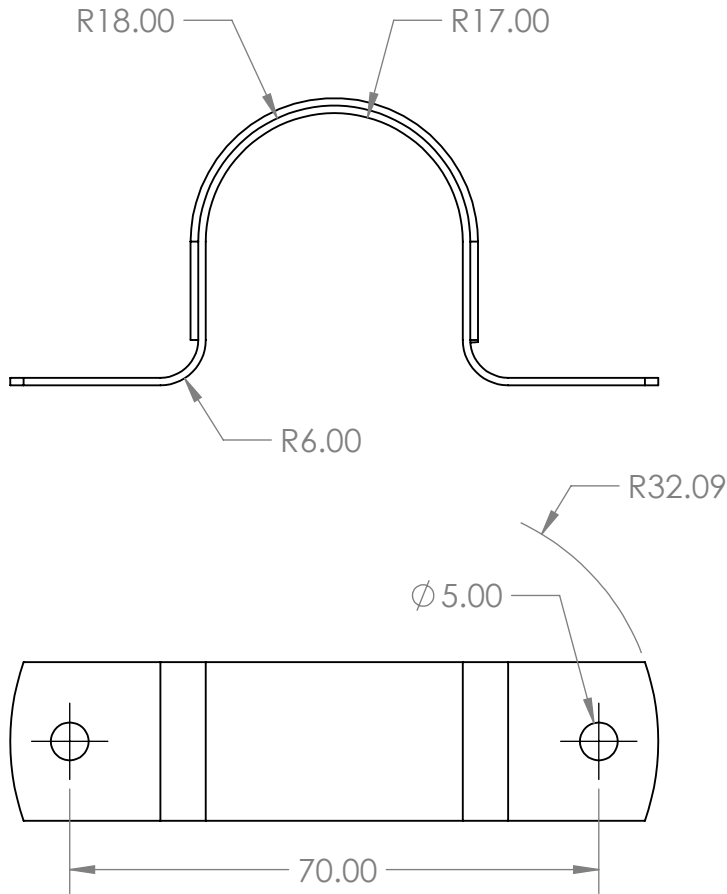

Description

- Complies to AS/NZS 3500
- Protected against electrolysis, corrosion and water hammering
- Suits Galvanised Pipes
- Also available in Chrome Plated

B

B

A

A



PROPRIETARY AND CONFIDENTIAL
 THE INFORMATION CONTAINED IN THIS DRAWING IS THE SOLE PROPERTY OF AZTEC AUSTRALASIA. ANY REPRODUCTION IN PART OR AS A WHOLE WITHOUT THE WRITTEN PERMISSION OF AZTEC AUSTRALASIA IS PROHIBITED.

		UNLESS OTHERWISE SPECIFIED:		NAME	DATE
		DIMENSIONS ARE IN INCHES	DRAWN		
		TOLERANCES:	CHECKED		
		FRACTIONAL ±	ENG APPR.		
		ANGULAR: MACH ± BEND ±	MFG APPR.		
		TWO PLACE DECIMAL ±	Q.A.		
		THREE PLACE DECIMAL ±	COMMENTS:		
		INTERPRET GEOMETRIC TOLERANCING PER:			
		MATERIAL			
		FINISH			
NEXT ASSY	USED ON				
APPLICATION		DO NOT SCALE DRAWING			

TITLE:		
SIZE	DWG. NO.	REV
A	IGSG25	
SCALE: 1:1	WEIGHT:	SHEET 1 OF 1

2

1